

Thank you very much for your purchasing of Electronic Apex Locator "i-ROOT™" from S-Denti Co., Ltd.

This instruction manual provides the method to measure the working length of root canal and information for the cautions.

This instruction manual has prepared for use of the dental clinic professionals.

i-ROOT™ is a registered trade mark of S-Denti Co., Ltd. The above company name and name of product are belonging to the properties of the company as registered trade marks.

S-Denti Co., Ltd. has the copyright of this instruction manual. A part or all parts of this manual shall not be reproduced or transmitted by any means of electronics, mechanic, and sound without permission by S-Denti Co., Ltd.

This manual and the product may hold wrong indications or technical faults, and those contents could be changed without notice in advance to improve the function of the product.

The pictures of images which have contained in this instruction manual may be different from the actual product.

The product has been tested for electromagnetic application test complied with EN60601-1-2, and it has designed to protect harmful interference reasonably against operation and installation of general medical equipments. This product could produce, use and discharge the energy of wireless wavelength, and it may cause harmful interference for other equipment nearby. In the event of harmful interference to other equipment by this product, the user shall take actions to resolve the interference with one or more recommendations which are described as below.

- Please reinstall and access again the product or change the receiver.
- Please keep distances further between this product and other which makes interference.
- Please use different receptacle.
- Please contact the agent of S-Denti Co., Ltd. or S-Denti Co., Ltd.

Cautions for Safety

The purpose of instruction manual is to keep safety of operators and patients and to prevent losses of property.
Please read it carefully prior to use the product.

<To use in right way for safety>

For Signals : This instruction manual contains various pictures not only to use the product correctly but also to protect damages or losses of properties for users or people to be accessed. The marks and meanings are as follows.

DANGER

If you use the product without care of this mark, you could be injured or death by wrong use.

CAUTION

If you use the product without care of this mark, you could have possibility to be injured or death by wrong use.

NOTICE

If you use the product without care of this mark, you could have possibility to be injured or death by wrong use or you could have incorrect measuring data.

 **DANGER**

- ※ This product shall not be used for the patient with pacemaker.
- ※ Please do not try to use this product with electric surgical operation instruments.
- ※ Please do not try to use it while the battery is being charged.
- ※ The other product or parts which have not approved by S-Denti Co., Ltd. shall not be connected or attached to this product. It could cause disorder or not to protect patient's safety.
- ※ Please do not try to use this product in the place where oxygen oxidized substance, nitrogen oxidized substance or combustibility anesthetic mixture are being. The explosion could be made.

 **CAUTION**

- ※ Please keep water away, because it is not water proof. Electric shock or damages on the product could be made.
- ※ Please do not try to disjoint the product. If you touch inside of the product, it could cause electric shock or burn. (If you disjoint the product intentionally, warranty service shall not be served irrespective of guarantee period.)
- ※ Please do not try to disjoint the product with exception of authorized repair man or trained professions by the S-Denti Co., Ltd. If it is touched inside of product, there is possibility for getting electric shock.
- ※ This product shall be used in the space of dental surgery only.
- ※ Please check the status of normal operation of the product prior to use.
- ※ The battery which has provided by S-Denti Co., Ltd. shall be used.
- ※ When the volume of battery is low (), please stop to use and recharge it.
- ※ When you recharge the battery, the adapter which has provided by S-Denti Co., Ltd. shall be used.
- ※ Please do not try to use it under the high humidity.
- ※ Please use it without affections from atmospheric pressure, wind, sun shine, and salt.
- ※ Please do not try to use it at the store of explosive products or gases.
- ※ Please stop to use it if it is wrong to operate.
- ※ Please do not try to it for others with exception of measuring working length of root canal.

 **NOTICE**

- ※ This product shall be used by dental clinic professionals only. Accidents could be caused by others.
- ※ Please keep the product away from high temperature or high humidity, and the shock shall be avoided. It could make explosion.
- ※ Please keep the metal parts of this product away from the conductor. The fire, electric shock, or disorder may be caused.
- ※ Please do not put the heavy material on the product. The fire or electric shock may be caused.
- ※ Please do not leave the battery longer time without charging. The life of battery could be shortened.
- ※ The measured teeth shall be confirmed for length by image of radiography.
- ※ The blocked root canal could not be measured correctly.

- ※ When you give this product to others, please the instruction manual shall be enclosed.
- ※ Information on maintenance, repair and replace of notice label.
 - Maintenance & repair: The label for notice or caution shall be maintained soundly with regular inspection.
 - Replace : Once the label for notice or caution has been lost or damaged, please contact to S-Denti Co., Ltd. We are going to send new one. (Charged - Payment when delivered).

CONTENTS

For better understanding, please read English instruction manual surely and carefully.

English **8~24**

1. Purpose of use and Operation principle	8
2. Product contents and its name	8
3. Check points prior to use	12
4. How to use	14
5. How to use PC software (optional)	19
6. To use in right way	21
7. Maintenance and Storage	23
8. Trouble shootings	24
9. Product specifications	24
<Quality guarantee and Responsibility>	87

French **25~31**

1. Mode d'emploi	25
2. Précautions d'emploi	29

German **32~37**

1. Bedienung	32
2. Die bestimmungsmäßige Verwendung	36

Spanish **38~44**

1. Instrucción de Us	38
2. Modos correctos de Uso	42

Italian 45~51

- 1. Modo di Uso 45
- 2. Modo dell'uso più esatt 49

Russian 52~58

- 1. Способ применения 52
- 2. Правильный способ использования аппарата 56

Arabic 59~65

- 1. كيفية الاستعمال 59
- 2. كيفية استعمال المنتج بصورة صحيحة 63

Korean 66~86

- 1. 사용 목적과 작동 원리 69
- 2. 제품의 구성과 명칭 69
- 3. 사용 전 점검 사항 73
- 4. 사용 방법 75
- 5. PC 소프트웨어 사용 방법 (선택사항) 80
- 6. 제품의 올바른 사용 방법 82
- 7. 보관 및 관리방법 84
- 8. 문제 해결 도움 85
- 9. 제품 규격 85
- 〈품질보증 및 책임의 한계〉 86

For better understanding, please read English instruction manual surely and carefully.

1. Purpose of use and Operation principle

1.1. Purpose of use

i-ROOT™ is Electronic Apex Locator, and it helps to operator for measuring of working length of root canal more correctly and safely as a supportive equipment.

⚠ NOTICE Please use the product to measure the working length of root canal only.

1.2. Operation principle

Micro signals consisting of dual frequencies coming from main unit return to where they are sent after travelling along the electric circuit that is composed of 'main unit - probe cord - file holder - file - patient - lip holder - probe cord'. In this case, the impedance of such electric circuit may be changed depending on the distance between the end of a file and the apex of the root canal, which results in a change in the micro signals that are input back into the main unit the micro process of the main unit calculates the change in micro signals to convert the difference into a distance value, which will be displayed on the LCD of the computer.









2. Product contents and its name

2.1. Name of contents and its function

Name	Functions
Probe cord	Probe cord links between the main unit and file holder, lip holder.
Lip holder	Holder to contact on patient's lip
File holder A	Holder(stick) to contact the file on (especially for molar teeth)
File holder B	Holder to put the file on
AC adapter (Charger)	Adapter for charging of battery exclusively which is stored in inside of the main unit
USB cable (optional)	USB cable to connect the main unit and PC
PC software CD (optional)	Device driver / CD for installation of computer monitoring and patient management system

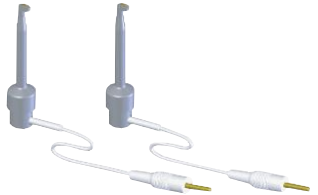
2.2. Contents of product

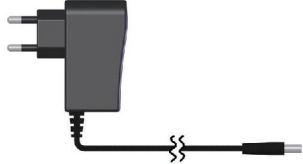
※ The contents of the product include optional.

 <p>1 Main unit iR-MB</p>	 <p>1 Battery (built-in type) iR-BATT</p>
 <p>1 Probe cord DLX-PC</p>	 <p>5 Lip holder DLX-LH</p>
 <p>1 File holder A DLX-FA</p>	 <p>2 File holder B DLX-FB</p>
 <p>1 Instruction manual PM-iR-02</p>	 <p>1 AC adapter (Charger) iR-ADPT</p>
 <p>1 USB cable 5m (Optional) iR-5UC</p>	 <p>1 PC software CD (Optional) iR-SW</p>

2.3. The name of main unit and its functions

Name	Functions
LCD	It shows the status of settings, and indicates the distance between the end of file inserted in root canal and root apex.
Control panel	Panel to select power On/Off and control of functions.
Multi-purpose Holder	Multi-purpose Holder.
Lamp as indicator for charge	The lamp shall be ON when the main unit and AC adapter have connected, and indicates the status of connection as red lamp for charging, green for charged completely.
Battery cover	To supply power with built in battery with 4.1V x 2 (DC 8.2V).
Probe cord jack	Jack which is connected to probe cord for measuring working length of root canal.
AC adapter jack	Jack which is connected to DC output plug of AC adapter for charging battery.
USB jack	Terminal (USB terminal) to communicate between computer and USB.
Adjustment switch (ADJ)	Mode for setting of root apex standard value and mode of buzzer volume adjustment shall be changed by pushing switch.
Down switch (DOWN)	By pushing the switch, the root apex standard value is decreased by 0.1 and the volume of buzzer is decreased as 1 step down.
Up switch(UP)	By pushing the switch, the root apex standard value is increased by 0.1 and the volume of buzzer is increased as 1 step up.
Setting switch(SET)	By pushing the switch, the setting mode shall be fixed.
Power switch (POWER)	Switch for ON/OFF of the main unit. By pushing the switch, it is ON/OFF alternatively.
Buzzer volume signal	Indicates the volume of Buzzer.
Graph signal	The graph shows the distance between the end of file and root apex.
Battery signal	Indicates the remained volume of battery.
Root apex signal	Shows that the end of file has reached to the setting standard value of root apex.
Numeric signal	Shows as number that the distance between the end of file and root apex.

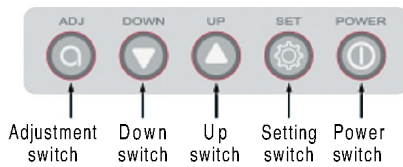
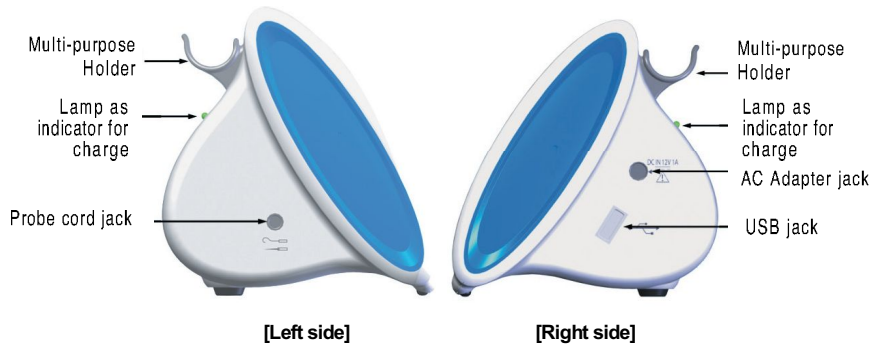
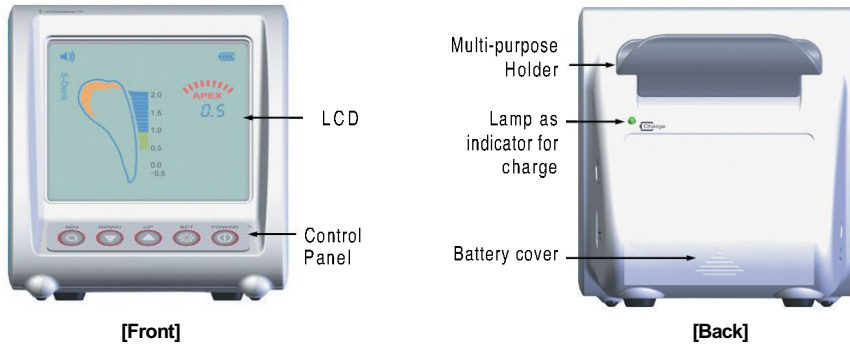

[Control Panel]

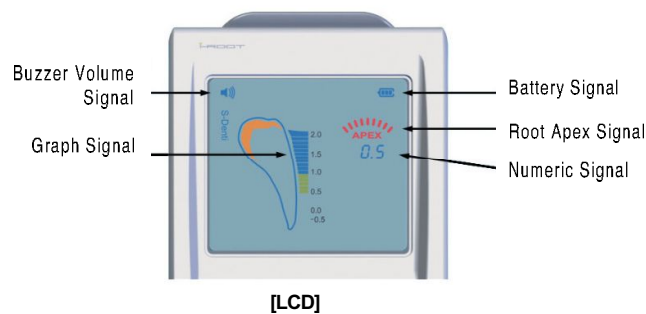

3. Check points prior to use

3.1. Check of contents

- 3.1.1. Please make sure all the components are placed inside when you purchase the product for the first time. (Please refer to '2.2 Contents of product.')
- 3.1.2. Please check the exterior of the product and whether there is damaged one or not. (The damages could be made during the delivery after ex-works.)

⚠ NOTICE *S-Denti Co., Ltd. shall not be responsible to the damages caused by carelessness of users.*

3.2. Check the battery volume

⚠ NOTICE *Once ex-works, the battery shall not be charged fully. When you purchased and start to use it, before using it at first, even it shows that the battery is charged fully, please charge the battery fully with AC adapter.*

⚠ NOTICE *When you charge the battery, you should use the AC adapter which has approved by S-Denti Co., Ltd..*

3.2.1. Please put the AC adapter into the wall socket. [Figure 3-2]

3.2.2. Please put AC adapter plug on AC adapter Jack of the main unit. [Figure 3-1]

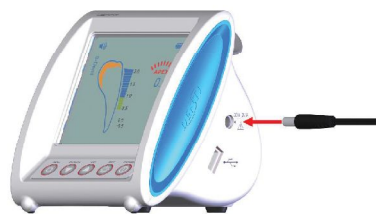

[Figure 3-1]

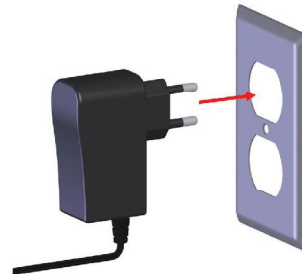

[Figure 3-2]

⚠ NOTICE *While the battery is charging, the product could not be used as designed. During the battery is charging, if the products is being ON, or is being operated, please disconnect AC adapter plug from AC adapter jack of the main unit, and ask to the agent or S-Denti Co., Ltd. for repair.*

3.2.3. Please check whether red lamp (charging) or green lamp (charged completely) is being ON or not in the backside of the main unit. [Figure 3-3]

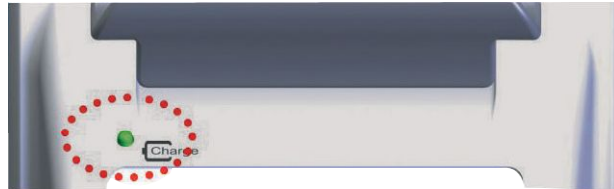

[Figure 3-3]

3.2.4. The red indicates incomplete charging of the battery. Please use the battery as fully charged as indicated green.

3.2.5. Once the green is ON, it means that the product is charged fully.

⚠ NOTICE Do not pull it out with holding of AC adapter code. AC adapter could be damaged or electric shock could be happened.

3.2.6. Once the green is ON, please pull AC adapter plug out.

⚠ NOTICE If you do not use it for long time, please check whether the power is off after 8 minutes automatically or not. If the power is not being OFF automatically after 10 minutes without using it, please stop use it, and the battery shall be disjointed from the main unit. And please contact to the agent or S-Denti Co., Ltd. for repair.

3.3. Check connection status between probe cord and file holder

3.3.1. Please input lip holder and file holder B into probe cord jack. [Figure 3-4]

3.3.2. Please input probe cord plug into probe cord jack of the main unit. [Figure 3-5]

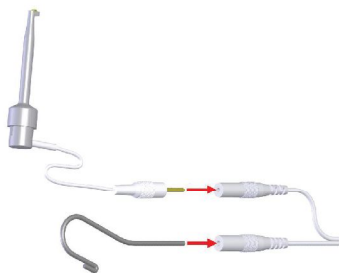

[Figure 3-4]



[Figure 3-5]

3.3.3. The file shall be hanging on the ring of file holder B. [Figure 3-6]

3.3.4. Please put the power ON for the product by pushing switch on control panel of the main unit. [Figure 3-7]

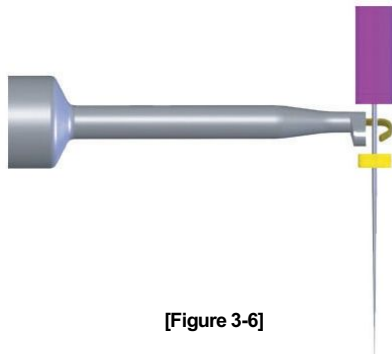

[Figure 3-6]



[Figure 3-7]

3.3.5. When contacting file hanging on the file holder B and lip holder, please check the digit 0.7 ~ 0.9 on the LCD screen. (In case the contact is loose, the value may be changed.) [Figure 3-8, Figure 3-9]

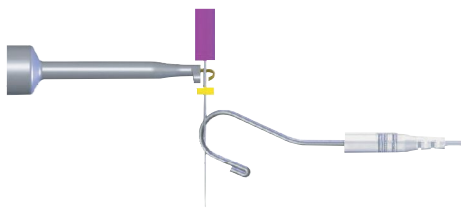

[Figure 3-8]

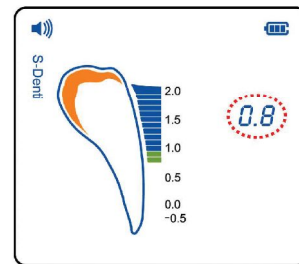

[Figure 3-9]

⚠ NOTICE Please check the status of connection from time to time between probe cord and file holder when you use it. Even though the status of connection is fine, but if the result is not being complied with the 3.3.5, the measuring results for root canal length could not be accurate. Please stop to use it and contact to the agent or S-Denti Co., Ltd. for repair. (There are some possibility for different result which is mentioned at 3.3.5 temporarily under the environmental factors like temperature and moisture.)

4. How to use

4.1. Probe cord connection

4.1.1. Please connect file holder and lip holder to probe cord.[Figure 4-1]

4.1.2. Probe cord should be connected to the probe cord jack of the main unit. [Figure 4-2]

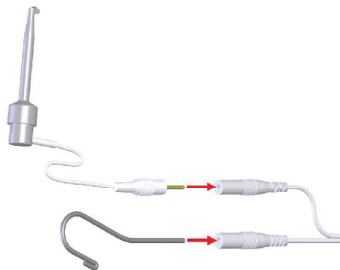

[Figure 4-1]



[Figure 4-2]

4.2. Setting of standard value for root apex

4.2.1. Please power ON by pushing power switch (POWER). [Figure 4-3]

4.2.2. Please push adjustment switch (ADJ) once. [Figure 4-4]

4.2.3. Please adjust desired value of root apex by pushing UP switch (UP) or Down switch (DOWN). (The standard value of the root apex is based on 0.5; when the desired value of root apex is to be changed to 1 or 0 position, $\pm 0.5\text{mm}$ shall be added to or subtracted from the apex value.) [Figure 4-5]

4.2.4. Please push Setting switch (SET), and then the desired value of root apex shall be fixed.



[Figure 4-3]



[Figure 4-4]



[Figure 4-5]



[Figure 4-6]

⚠ NOTICE The standard value of root apex of i-ROOT™ is set as 0.5 from factory. It means that the file has reached to physiological foramen, and it is away about 0.5mm from anatomical foramen. (Electronic Apex Locator's standard location of root apex and indication value of root apex location could be different from the manufacturers or the types of product).

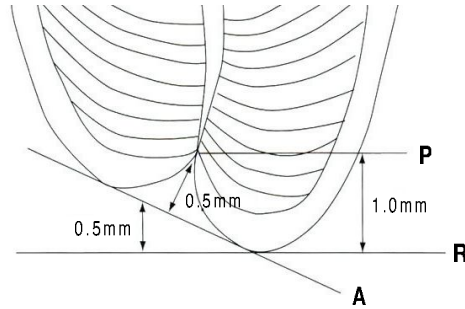

P: Physiological foramen,
constriction point, CDJ;
cemento-dental junction

R: Radiographic apex

A: Anatomical foramen

4.3. Setting of buzzer volume

- 4.3.1. Please power ON by pushing power switch (POWER). [Figure 4-7]
- 4.3.2. Please push the adjustment switch (ADJ) two times.[Figure 4-8]
- 4.3.3. Please adjust the volume of buzzer by UP switch (UP) or DOWN switch (DOWN).[Figure 4-9]
- 4.3.4. Please push the setting switch (SET) to fix the volume of buzzer.[Figure 4-10]



[Figure 4-7]



[Figure 4-8]



[Figure 4-9]



[Figure 4-10]

[Type of buzzer volume]



Loudest sound



Louder sound



Smaller sound



No sound

4.4. Measuring the working length of root canal

4.4.1. Please power ON by pushing the power switch (POWER).

⚠ NOTICE *When the lip holder has taken out from the factory, it has not been sterilized. It shall be sterilized by high steam sterilizer at 121°C for 30 minutes before using it. It shall be sterilized to use for individual patient.*

4.4.2. Please put the lip holder on patient's lip. [Figure 4-11]

4.4.3. Please put file into the teeth of patient. [Figure 4-12]

⚠ NOTICE *Please put the lip holder in opposite direction from the file.*

4.4.4. Please put file holder B on the file (In case of file holder A, please contact). [Figure 4-13]



[Figure 4-11]

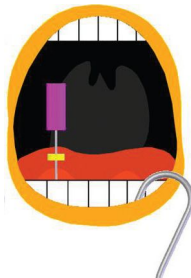

[Figure 4-12]

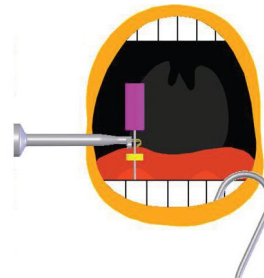

[Figure 4-13]

4.4.5. Please move the file slowly along the root canal while you check the graph and the number value on the LCD; when you should stop the movement when the distance between the the end of file and root apex reaches the standard value of root apex (which is preset at 0.5mm when it is shipped out of the factory) or your changed (desired) value of root apex and the signal of the root apex "APEX" starts to blink to inform the file is reached to the apex. At this point, please proceed with the file farther to 0.4 (in case the standard value of root apex is set at 0.5), where you can move it back until the standard value of root apex shows 0.5. It helps to find an more exact location of the apex. [Figure 4-14 ~ Figure 4-16]

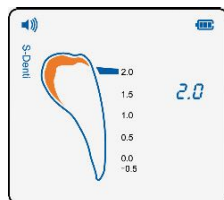

[Figure 4-14]

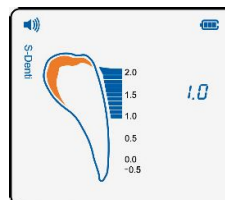

[Figure 4-15]

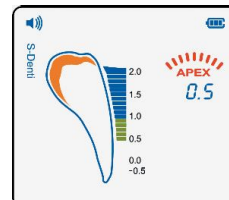

[Figure 4-16]

- 4.4.6. After positioned Rubber Marker of file at teeth standard point, the file shall be moved from the teeth.
- 4.4.7. Please measure the working length from the end of file to Rubber Marker by scale.

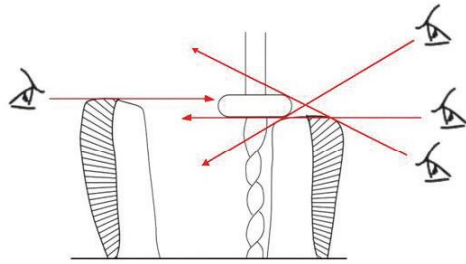

NOTICE

The measuring result of Electronic Apex Locator could be different by Rubber Marker of file and the position of eye.

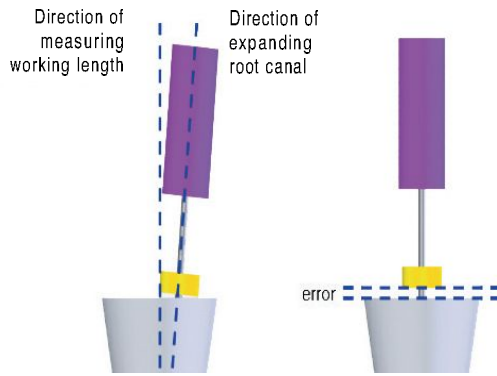

NOTICE

There are some possibilities for the difference of measured working length because the direction of the file is not same when you expand the root canal and when you measure the working length.

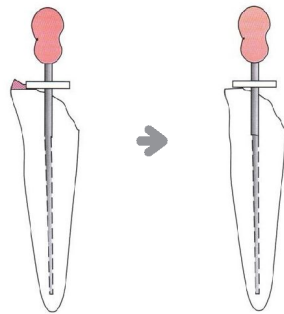

NOTICE

There may be a case in which a part of tooth has to be ground off in order to maintain a stable reference point.

- 4.4.7.1. Please power OFF. (The power shall be OFF automatically after 8 minutes, if the switch has not pushed or the measuring has not made).
- 4.4.7.2. The working length of root canal measured and the image of radiography shall be confirmed mutually.

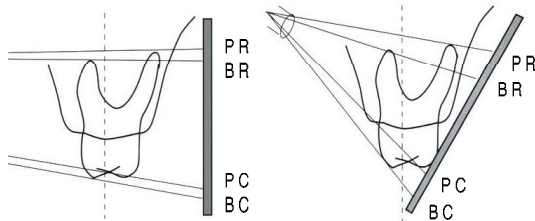

NOTICE

A image of radiograph may show a different measurement result depending on the location of radiation part and photosensitive part.

English

www.s-denti.com

5. How to use PC software (optional)

5.1 Method of installing PC software

- 5.1.1. Please put PC software CD into computer.
- 5.1.2. Please install USB driver. [Figure 5-1]
- 5.1.3. Please install APEX program (PC software program) for computer monitoring and Patient management system. [Figure 5-2]

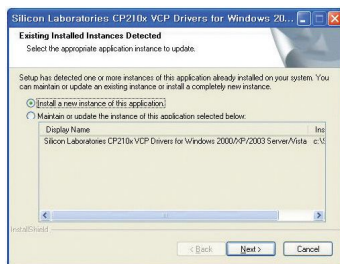

[Figure 5-1]

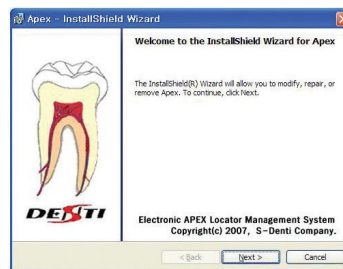

[Figure 5-2]

5.2 Start PC software

- 5.2.1 Please connect PC and main unit with a USB cable.
- 5.2.2 Please turn on the power of the main unit.
- 5.2.3 Please verify the port number allocated to the main unit at Windows Device Manager. [Figure 5-3]
- 5.2.4 Please run the installed APEX program.
- 5.2.5 Please select the port number allocated to the main unit from among COM1~COM8. [Figure 5-4]

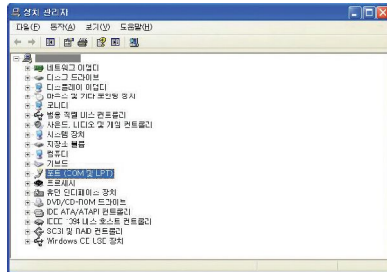

[Figure 5-3]



[Figure 5-4]

5.3 Input Information on a new patient

- 5.3.1 Please type in the surname, last name and patient identity code. (Patient identity code can not be designated twice.)
- 5.3.2 Please store the input information by pressing 'New Patient' button.

5.4 Open restored patient information

- 5.4.1 Please type in the surname, last name or identity code of a patient. (You are recommended to use the patient identity code because the information can not be opened if there are patients who use the same family names or same last names. You can also open patient information only with a patient identity code.)
- 5.4.2 You can open patient information with a click of 'SEARCH' button. (It is possible to move to 'MEASUREMENT' window without the input of the information of a patient; however, a patient should be selected to save a measurement value. Therefore, patient information is advised to be selected before a measurement is performed.)

5.5 Measure the working length of the root canal and save it.

- 5.5.1 Please input new patient information or open stored patient information.
- 5.5.2 Please click 'Measurement' button.
- 5.5.3 Please measure the working length of the root canal. (The value displayed on the APEX program could appear later than that shown on the LCD of the main unit because of the specification of a PC or peripheral devices on the computer.)
- 5.5.4 Please input the number of the tooth which is measured, measured working length, and other remarks to be recorded.
- 5.5.5 Please click 'SAVE' button to store the input data

5.6 Print out stored measurement values in a hard form.

- 5.6.1 Please select the information of a patient. [Figure 5-7]
- 5.6.2 Please click 'PRINT' button to print out the patient information stored in 'Patient History'.

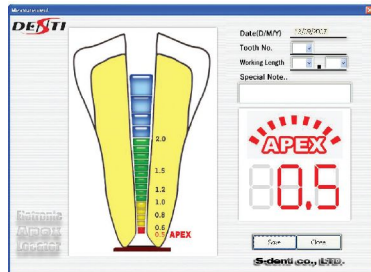

[Figure 5-5]

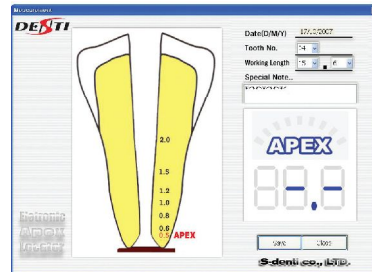

[Figure 5-6]

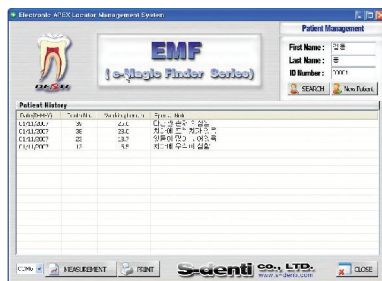

[Figure 5-7]

6. To Use in right way

6.1. Guide for making accurate measurement

- 6.1.1. Please power on prior to use.
- 6.1.2. It is advisable measurement way that put a half of file along with the canal first, and then connect file to file holder.
- 6.1.3. In case of no indication when the file reached to the APEX, it has possibility that the root canal would be dried perfectly. It is advisable measurement way that the dried root canal should be filled with saline.
- 6.1.4. If there is foreign materials like irrigants in the mouth, there has possibility for electric leakage between file and lip holder through the above foreign materials. It is advisable measurement way that remove the foreign materials which are in the mouth.
- 6.1.5. If necrotic dentin and cementum in the root canal are not removed, there are possibility for mis-measurement. It is advisable for you to enlarge the root canal with a enough size of file which can be felt slight resistance (snuggly binding) in side of root canal.

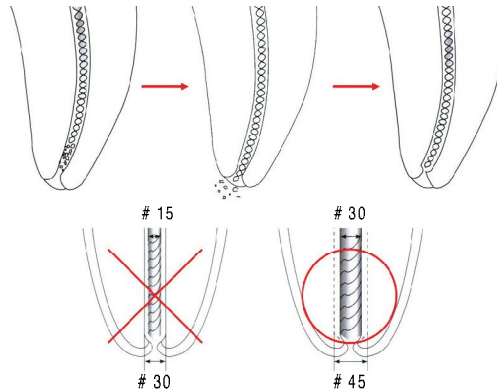

- 6.1.6 Please start with a thick file at first; If the Apex indication (graph and digital no. on the screen) does not reach the apex, you gradually try a thinner file to measure an exact working length of the root canal.
- 6.1.7. Please do not stop measurement at a first try; you are advised to try more than twice to measure the working length to minimize an error.
- 6.1.8. The surface of tooth should be dry.
- 6.1.9. In case of a tooth with multiple root canals, because of such factors as cracks in the tooth, if the space of each root canal is connected, there may be an error occurrence. You are advised to verify if there are cracks and the likes in the tooth by taking a radiograph.
- 6.1.10. In case of a tooth with multiple root canals, there are possibility of exudation connection between root canals and so if the Apex indication (graph and digital no. on the screen) is not certain, please measure the working length with observation for the condition of canal for more accurate measurement.
- 6.1.11. If there are metal restorations on the teeth to be measured, you take a careful attention not to let them be connected to either the root canal, the file or lip holder, because their connection to or contact with the root canal can result in an error.
- 6.1.12. Even though the product is checked at 0.8 in accordance with the method described in "3.3 Check connection status between probe cord and file holder", a measurement exceeds the standard value of the root apex which is 0.5 as soon as a file is put into the root canal, it is due to an electric leakage caused by such diverse factors as wrong formation of root canal, excessive mouth wash, cracks in tooth, metal restorations etc, in which case another measurement should be performed after the electric leakage is eliminated.
- 6.1.13. When exudate or blood rises up along the root canal during measurement, it is advisable to measure the working length after getting rid of such foreign materials inside the canal using a paper points.
- 6.1.14. In case of a foramen at initial growth stage whose root canal apex is not completely formed or a foramen that was overly expanded due to excessive cutting, the measurement value of working length may be shorter than actual measurement value.

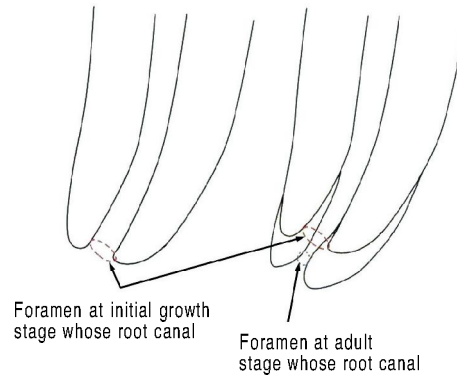

7. Maintenance and Storage

7.1. Sterilization

- 7.1.1. The used lip holder and file holder shall be dry sterilized at 121°C for 30 minutes with steamed high pressure.
- 7.1.2. Used file holder B should be disinfected at temperature of 121°C for 30 minutes in an individual sterilization wrapper or pouch. The metal of the file holder B may be corroded when it is in direct contact with steam.

⚠ CAUTION Please make sure to sterilize all the components (such as lip holder, file holder and so on) that can be in direct contact with or can be possibly in contact with patients. They may be infected.

⚠ NOTICE Temperature should not exceed 135°C when in sterilization. The product may be damaged.

7.2. Cleansing

- 7.2.1. Please cleanse the foreign materials stuck to main unit or probe cord with dry gauze wetted with a small amount of ethanol the ethanol left on the product after the cleansing should be completely wiped out with a dry cloth.

⚠ CAUTION Please do not use the product when either ethanol is left on the metal part of the product (probe cord jack, AC adaptor jack, USB jack and so on) or foreign material is stuck to it; there might be a possibility of your receiving an electric shock or of the product being damaged.

7.3. Storage

- 7.3.1. Please keep it in the place under the temperature : -20 ~ 70°C, atmospheric pressure : 50kPa ~ 106kPa, and humidity : 0 ~ 95%.

8. Trouble Shootings

If any problem has occur, please refer to the table as below. If you have further problems or any other issues, please contact to the agent of S-Denti Co., Ltd. or S-Denti Co., Ltd.

Problems	Causes Expected	Solutions
No power on	Low Battery	Charge the battery
	No Battery	Check the connection to the battery
	Connected to AC Adapter	Disconnect AC Adapter
No indication of Lamp as indicator for charge	Disconnected AC Adapter	Connect AC Adapter
	Disconnected AC Adapter Plug from receptacle	Check the connection of AC Adapter
	Power OFF on connected AC Adapter to receptacle	Check the connection of AC Adapter
No Buzzer Sound	No Sound Setting	Adjust the volume of buzzer sound
Power ON, but not measured	Probe cord disconnected from the main unit	Check the connection of probe cord and the main unit
	File holder disconnected from probe cord	Check the connection of file holder and probe cord

9. Product Specifications

9.1. The Main unit

- 9.1.1. Rated voltage : Lithium-ion battery 8.2VDC (4.1VDC x 2)
- 9.1.2. Input current : DC 40mA
- 9.1.3. Power consumption : 0.33VA
- 9.1.4. Patient auxiliary current: less than AC10mA
- 9.1.5. Oscillation frequency : 500Hz, 5kHz
- 9.1.6. Size: W 110mm × D 112mm × H 117mm
- 9.1.7. Weight: 372g ± 24g
- 9.1.8. Protection type and level against electric shock: Inner Power Type Equipment, BF Type Equipment

S-Denti Co., Ltd.

Phone : +82-2-2627-3765~8 Fax: +82-2-2627-3769
E-mail : overseas@s-denti.com / www.s-denti.com